

Hyflex™ Lectern  
 Atril Hyflex™

55570

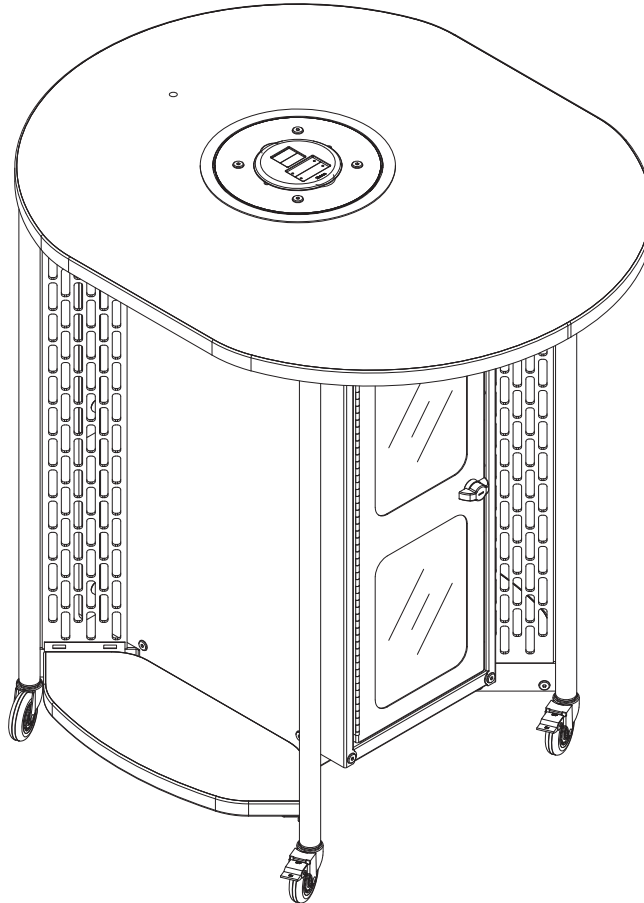

<p align="center"><b>⚠ Important ⚠</b></p> <p>Before using this product:</p> <ul style="list-style-type: none"> <li>• Read this manual</li> <li>• Comply with all safety and operating instructions</li> <li>• Ensure all parts and correct quantities are included</li> </ul> <p>Any parts damaged during shipment must be reported within 5 days of receipt. To report information regarding missing parts or damage, to purchase parts or accessories, or if you have any questions, please contact us.</p> <p align="center">Thank you for purchasing Spectrum products!</p>	<p align="center"><b>⚠ Important ⚠</b></p> <p>Avant d'utiliser ce produit:</p> <ul style="list-style-type: none"> <li>• Veuillez à lire ce guide</li> <li>• Respectez les consignes de sécurité et d'utilisation</li> <li>• Vérifiez que vous disposez de toutes les pièces nécessaires à l'installation</li> </ul> <p>Les pièces endommagées pendant le transport doivent faire l'objet d'un rapport dans les 5 jours de leur réception. Veuillez prendre contact avec nous si des pièces manquent ou sont abîmées, si vous avez des questions, ou encore pour acheter des pièces ou des accessoires.</p> <p align="center">Merci pour votre achat d'un produit Spectrum!</p>	<p align="center"><b>⚠ Importante ⚠</b></p> <p>Antes de utilizar este producto:</p> <ul style="list-style-type: none"> <li>• Lea este manual</li> <li>• Cumpla con todas las instrucciones de prevención de accidentes y operativas</li> <li>• Revise que todas las partes y las cantidades correctas estén incluidas</li> </ul> <p>Si alguna parte se dañó durante el embarque, deberá reportarla en un lapso de 5 días a partir de la recepción. Para reportar cualquier información sobre partes faltantes o dañadas, para adquirirlas o comprar accesorios, o bien, si tiene alguna duda, póngase en contacto con nosotros.</p> <p align="center">¡Gracias por adquirir productos Spectrum!</p>
--	--	---



<http://www.spectrumfurniture.com>

 <p>Specs Spécifications Especificaciones</p>	 <p>Instructions Le instructions Instrucciones</p>	 <p>Video Vidéo Vídeo</p>
--	---	--



 **800-235-1262**

## Components

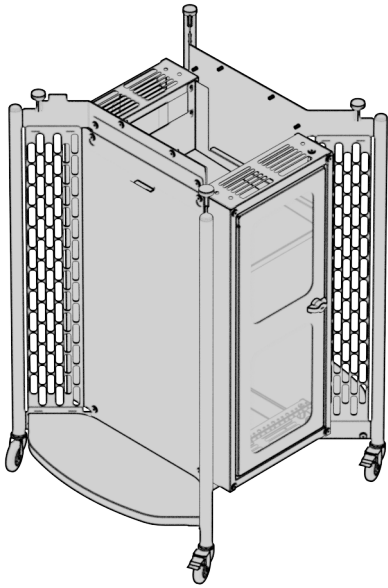

(1) Lectern assembly

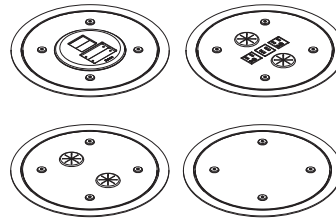

(1) Interface panel  
(specific panel may vary)

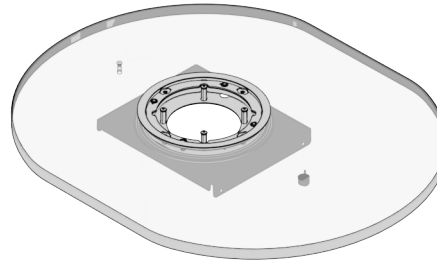

(1) Worksurface assembly

## Hardware

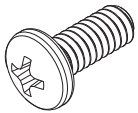

(4) 026064  
1/4"-20 x 5/8"  
PHMS



(4) 038391  
1/4" Star washer  
external tooth



(1) 044555  
3/8" hole plug



(1) 025039  
4mm hex  
wrench

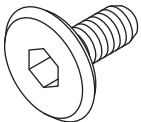

(4) 052605  
1/4"-20 x 15mm  
JC bolt



(1) 038702  
3/8" Flat Steel Washer  
for optional monitor arm  
(sold separately)



(1) 0183867  
Multi-purpose white  
grease packet .03 oz

## Tools



X2

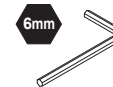
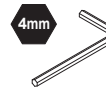

Screwdriver with  
#3 Phillips bit



Assembly tip: Do not tighten component fasteners completely until all have been installed. Keeping them loose will help with alignment between parts during assembly.

# 1 Attach worksurface assembly to lectern base

1. Set the worksurface assembly onto the lectern base as shown and align the (4) mounting holes. Be sure the rubber bumper under the worksurface is located above the acrylic door.
2. Install (4) 1/4-20 x 5/8" PHM screws with external tooth lock washers.
3. Tighten screws securely.

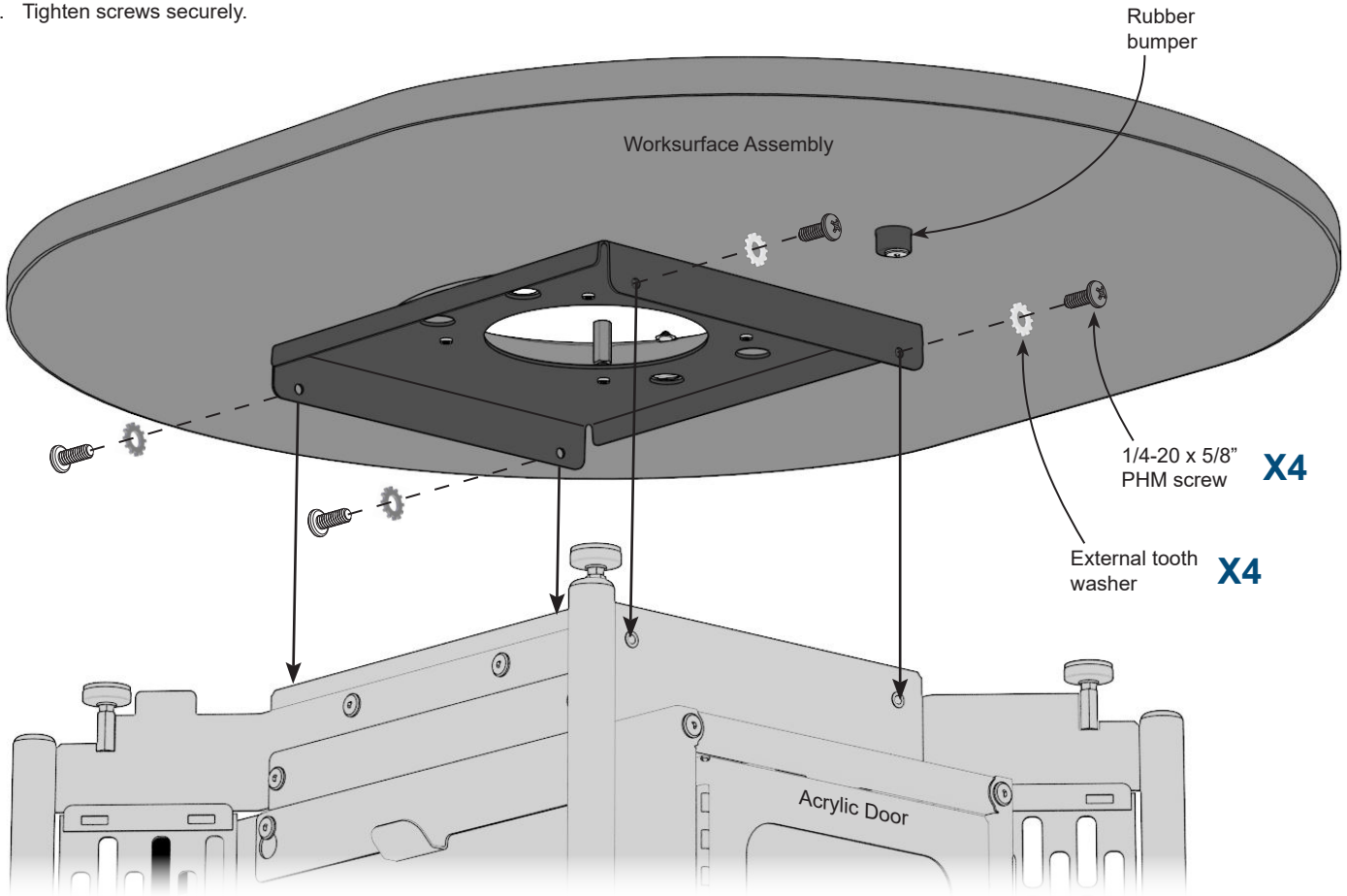

# 2 Grease interface panel

1. Fill each of the 16 counter-sunk holes on the underside of the interface panel with assembly grease.

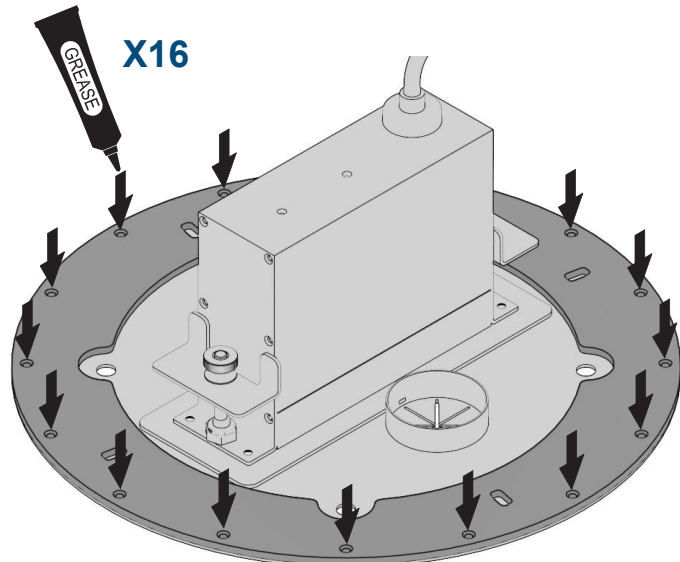

# 3 Install interface panel

1. Place the greased interface panel into the lectern worksurface.
2. Attach the panel with (4) 1/4-20 x 15mm JC bolts.

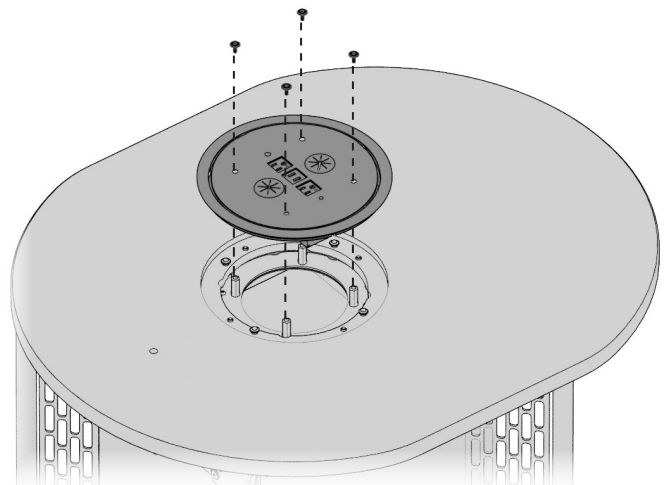
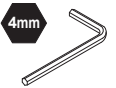

## Audience-side panel



Note: Using key, turn lock cam 90° counterclockwise before installing the audience-side panel, then lock after panel is in place.

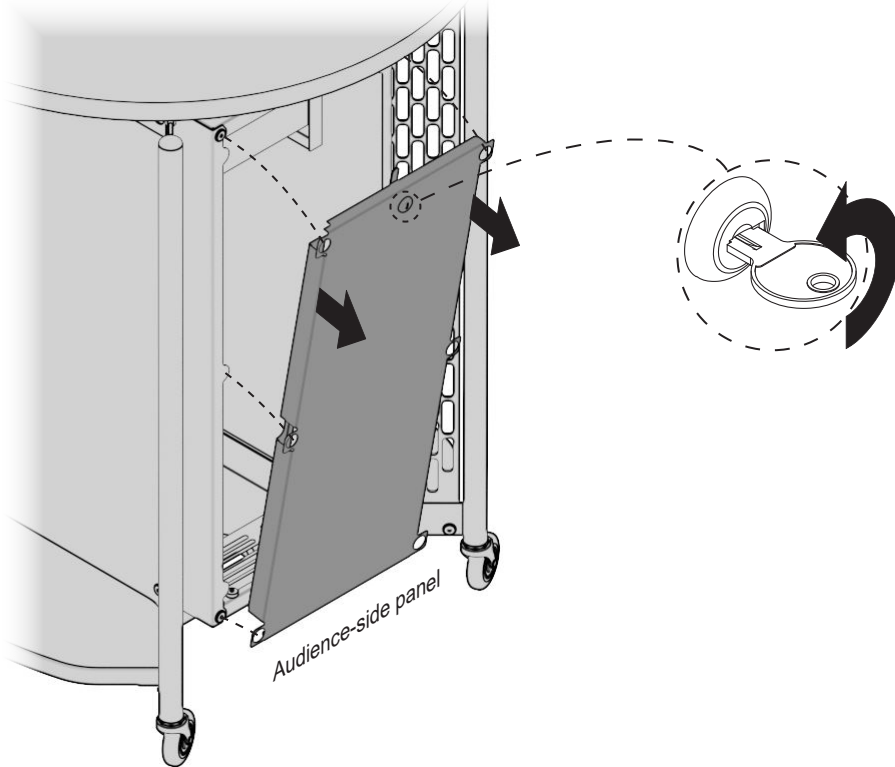

## Installing monitor arm (optional)

The lectern includes a washer used to install an optional monitor arm (available separately). See p.7 for monitor arm options. If not using a monitor, install the 3/8" hole plug in the worksurface.

1. Do not use the square plate included with the monitor arm.
2. Install the included 3/8" flat washer onto the monitor arm mounting screw.
3. Align the monitor arm base with the pre-drilled worksurface hole and thread the mounting screw/washer from under the worksurface.
4. Tighten securely with 6mm hex wrench.

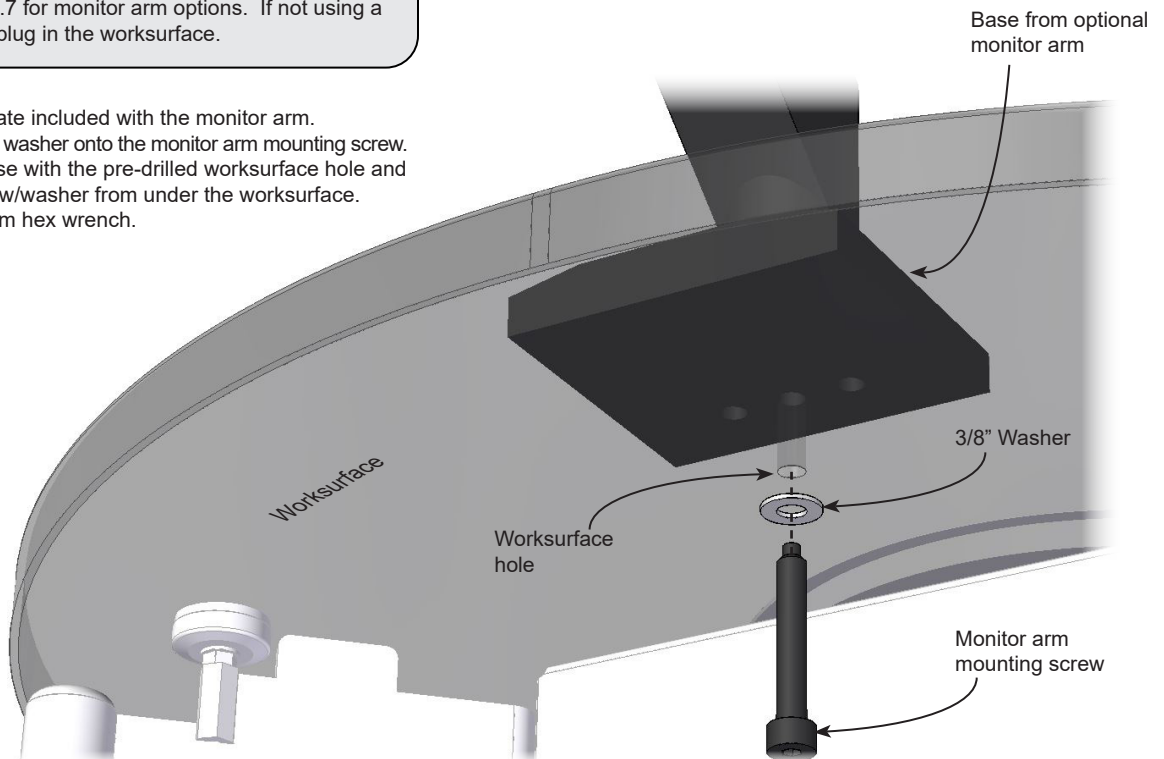
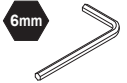

## Locking casters

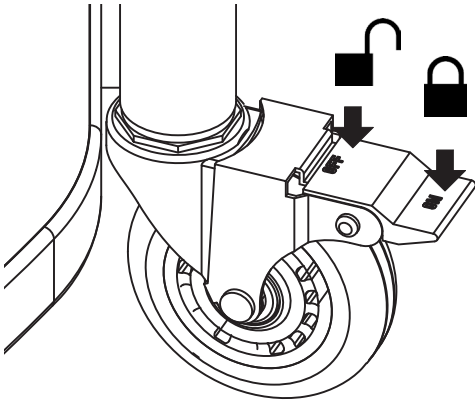

## General maintenance

The interface panel should be re-greased after approximately 2500 cycles of rotation. See p.3.



## Accessories

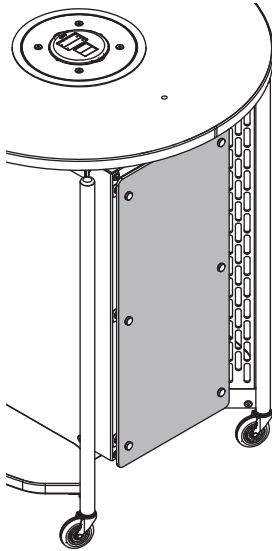

### Customized Logo Panel (full-height) - 55572

- Attaches to audience-side panel with heavy-duty magnets
- Clear acrylic
- Aluminum stand-offs
- To get panel customized, contact Spectrum for details
- New logos require a first time logo charge
- Customer-installed

Panel dimensions:	13.438"W [34.13 cm] x 30.28"H [76.9 cm] x .25"D [6.35 mm]
Available logo area:	11.438"W [29 cm] x 25.5"H [64.8 cm]
Unit weight:	5 5 lb [2.3 kg]
Shipping weight:	9 lb [4.1 kg]

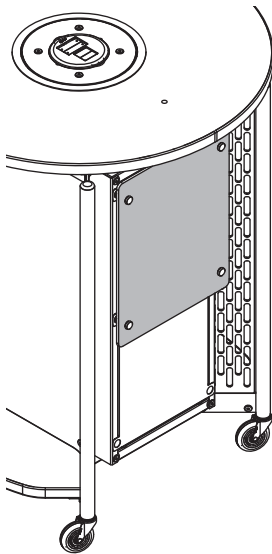

### Customized Logo Panel (half-height) - 55571

- Attaches to audience-side panel with heavy-duty magnets
- Clear acrylic
- Aluminum stand-offs
- To get panel customized, contact Spectrum for details
- New logos require a first time logo charge
- Customer-installed

Panel dimensions:	13.438"W [34.13 cm] x 17.14"H [43.5 cm] x .25"D [6.35 mm]
Available logo area:	11.438"W [29 cm] x 12.4"H [31.5 cm]
Unit weight:	3 lb [1.4 kg]
Shipping weight:	5 lb [2.3 kg]

## Worksurface Interface Panels

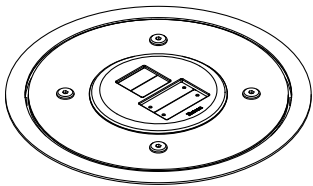

**Cable Cubby 100 - 55574**  
(CC100 not included)

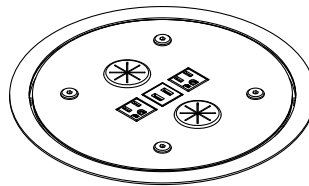

**Dock 1100 - 55575**  
(2 AC outlets, 2 USB-C ports)

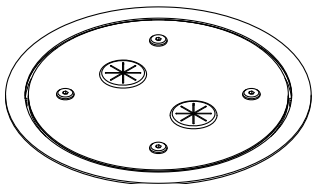

**Grommet - 55573**

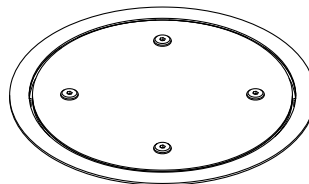

**Custom - 55576**  
(6" diameter of available space)

Note: Spectrum can customize a blank interface panel to your device specifications within the 6" diameter available as long as there is clearance of objects under the worksurface.

Contact Spectrum for customizing details.



### Summit Monitor Arm - 95539

- For monitors weighing 2.2-32 lb, and 17"-35"
- Mounts using with clamp or grommet hole
- Compatible with all VESA® monitors - 75mm / 100mm VESA® adapter
- Cable management concealed in arm



### Titan Monitor Arm - 95509

- For monitors weighing 12-31 lb
- Six mounting options (clamp, thru-desk, wall, grommet hole, side bolt, reverse wall)
- Compatible with all VESA® monitors includes 75mm and 100mm VESA® adapters
- Cable management concealed in arm

Note: The 95539 Summit and 95509 Titan monitor arms are the only monitor arms compatible with the Hyflex Lectern.



### 7-Outlet Power Strip - 99024

- Electrical Rating: AC 125V, 15 Amps
- 1000 Joules surge capacity
- 12' cord length
- LED switch
- UL Listed
- Shipping weight: 1.9 lb [.86 kg]

## Rack-mount Accessories

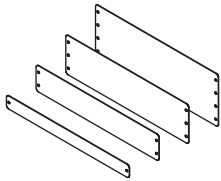

### Rack-Mount Blanks

1RU - 97510    3RU - 97512  
2RU - 97511    4RU - 97513

- Fills rack spaces where components are not needed
- 16 ga steel
- Shipping weight: <1 lb [.45 kg]

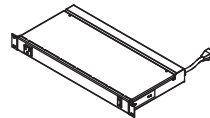

### 9-Outlet Power Strip - 1RU - 99021



- 8 outlets rear (breaker-protected)
- 1 convenience outlet front
- 115VAC, 60 Hz, 15 amps max
- 9' power cord
- Front LED power switch
- Enhanced surge protection
- ETL-listed, UL-listed
- 19"W [48.27 cm] x 9.25"D [23.5 cm] x 1.74"H [4.41 cm]
- Shipping weight: 8.7 lb [3.9 kg]

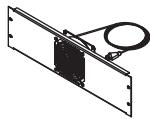

### Single Fan - 3RU - 97507

- 50 cfm
- 120V~50/60 Hz, 15/13W
- RoHS
- 19"W [48.27 cm] x 1.56"D [3.97 cm] x 5.25"H [13.33 cm]
- Shipping weight: 3.78 lb [1.7 kg]

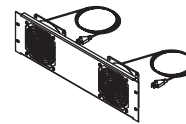

### Double Fan - 3RU - 97506

- 100 cfm
- 120V~50/60 Hz, 15/13W
- RoHS
- 19"W [48.27 cm] x 1.56"D [3.97 cm] x 5.25"H [13.33 cm]
- Shipping weight: 5.47 lb [2.5 kg]

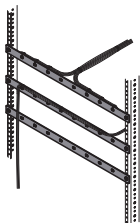

### Wire Lace Kit - 95517

- Provides wire management
- Mounts to standard rack rails
- Includes (3) lace straps and mounting screws
- Includes (12) 5.5" zip ties
- Shipping weight: 1.25 lb [.57 kg]

See [spectrumfurniture.com](http://spectrumfurniture.com) for the latest accessories and detailed warranty information.



## Important Safety and Care Instructions



- Read this owner's manual before assembly or operation.
- Do not allow children to move the cart.
- Proceed slowly and carefully when moving the cart.
- For indoor use only. Do not install or store the cart where it will be exposed to moisture.
- Do not block the ventilation openings.
- Avoid uneven loading of the equipment into the cart. Uneven weight distribution could cause the cart to tip when the cart is moving.
- Do not allow anyone to sit, stand, or climb on the cart.
- Use a damp, soft-cloth, or sponge, with mild soap or detergent solution to clean dirty surfaces. Do not use harsh solvents or abrasives.
- This cart is intended for institutional use. It does not have any user-serviceable parts or user-maintenance requirements. If servicing is necessary, please contact Spectrum Industries for assistance.

**Warning** - Relocating audio and/or video equipment to furniture not specifically designed to support audio and/or video equipment may result in death or serious injury due to the furnishing collapsing or over turning onto a child.

**Warning** - Death or serious injury may occur when children climb on audio and/or video equipment furniture. A remote control or toys placed on the furnishing may encourage a child to climb on the furnishing and as a result the furnishing may tip over on to the child.

### Electrical Safety:

- Keep the power switch in the OFF position before plugging or unplugging from the wall outlet.
- Turn OFF the devices before plugging them into the cart.
- Ensure total device / equipment load does not exceed 12-amps.
- Do not plug the power cord into an extension cord.
- Inspect the power cords for damage before each use. Do not use power cords that are damaged.
- Unplug power cord from electrical outlet by gripping the plug. Do not unplug the power cord by pulling only on the cord.
- Do not step on, drive over, drag, or place objects on the power cord.
- For added safety, plug the cart into a grounded outlet controlled by a GFI (Ground Fault Interrupter) circuit breaker.
- Damaged electrical components can create significant hazards to users and is not covered by the warranty. Repairs should always be performed by a qualified electrician.
- Electrical devices are not toys. Children are often unaware of the hazards associated with electrical devices. This cart must always be used by adults or with adult supervision.



## Consignes importantes de sécurité et d'entretien



- Lire ce guide d'utilisation avant l'assemblage ou l'utilisation.
- Interdire aux enfants de déplacer l'armoire.
- Déplacer l'armoire lentement et prudemment.
- Utilisation à l'intérieur uniquement. Ne pas assembler et ne pas ranger l'armoire dans un endroit humide.
- Ne pas boucher les prises d'air de ventilation.
- Éviter le chargement mal réparti de l'équipement sur l'armoire. Un chargement mal réparti risque de faire basculer l'armoire en déplacement.
- Interdire à quiconque de s'asseoir, de se tenir debout ou de grimper sur l'armoire.
- Passer un chiffon doux ou une éponge, imbibés de solution nettoyante ou de savon liquide doux, sur les surfaces sales. Ne pas utiliser des solvants rudes ou des abrasifs.
- Cette classe mobile est destinée à un usage collectif. Elle ne contient aucune pièce susceptible d'être réparée par l'utilisateur et ne nécessite aucun entretien de la part de celui-ci. Si une maintenance est requise, communiquer avec Spectrum Industries pour obtenir de l'aide.

**Avertissement** - Reloger un équipement audio ou vidéo sur un meuble non conçu pour supporter cet équipement pourrait entraîner de graves blessures, voire la mort, à la suite de l'effondrement du meuble ou de sa chute sur un enfant.

**Avertissement** - Un enfant qui grimpe sur un meuble d'équipement audio ou vidéo pourrait subir des blessures graves ou mortelles. Une télécommande ou des jouets placés sur le meuble risquent d'inciter un enfant à y grimper : le meuble pourrait alors basculer et écraser l'enfant.

### Consignes de sécurité en électricité

- Mettre d'abord l'interrupteur sur Arrêt avant de brancher ou de débrancher la prise.
- Éteindre les appareils avant de les brancher à l'armoire.
- Assurez-vous que la charge totale appareils / équipements n'exécède pas 12A.
- Ne pas brancher le cordon d'alimentation sur une rallonge.
- Vérifier que les cordons d'alimentation sont intacts avant chaque utilisation. Ne pas les utiliser s'il sont abîmés.
- Pour débrancher le cordon de la prise murale, saisir son bouton isolant et tirer; ne pas tirer le cordon.
- Ne pas marcher, ne pas rouler et ne pas placer des objets sur le cordon d'alimentation; ne pas le traîner.
- Pour plus de sécurité, brancher l'armoire sur une prise mise à la terre protégée par un disjoncteur de fuite de terre.
- Les composants électriques abîmés risquent d'exposer les utilisateurs à de graves dangers; ils ne sont pas couverts pas la garantie. Toujours confier les réparations à un électricien qualifié.
- Les appareils électriques ne sont pas des jouets. Les enfants n'ont souvent pas conscience des dangers associés aux appareils électriques. Cette armoire doit donc être toujours utilisée par un adulte, ou sous la surveillance d'un adulte.



## Instrucciones importantes de prevención de accidentes y cuidado



- Lea este manual del propietario antes de la instalación u operación.
- No permita que los niños muevan el carro.
- Proceda lenta y cuidadosamente al mover el carro.
- Solo para uso en interiores. No instale o guarde el carro donde quede expuesto a la humedad.
- No obstruya las rendijas de ventilación.
- Evite cargar el equipo de forma desigual dentro del carro. La distribución asimétrica del peso podría provocar que el carro se vuelque al momento de moverlo.
- No permita que nadie se sienta, pare o suba al carro.
- Para limpiar las superficies sucias, utilice un paño, trapo suave o esponja con jabón neutro o una solución de detergente. No utilice solventes o abrasivos ásperos.
- El uso convencional de este carro es institucional. No contiene ninguna parte que pueda ser reparada ni requiere de mantenimiento por parte del usuario. Si fuera necesario darle mantenimiento, póngase en contacto con Spectrum Industries para obtener asistencia.

**Advertencia:** reubicar equipo de audio y/o video a un mueble que no haya sido diseñado específicamente para tal uso, puede provocar la muerte o lesiones graves debido a que puede colapsarse o volcarse sobre un niño.

**Advertencia:** existe peligro de muerte o lesiones graves si los niños se suben a un mueble de equipo de audio y/o video. Un control remoto o juguete colocado sobre el mueble puede alentar a un niño a subirse y provocar que el mueble se vuelque sobre el chico.

### Prevención de accidentes eléctricos:

- Mantenga el interruptor de alimentación en la posición de OFF [apagado], antes de enchufarlo o desenchufarlo del tomacorriente de pared.
- Apague los dispositivos antes de enchufarlos al carro.
- Revise que la carga total del dispositivo o del equipo no exceda los 12 amperios.
- No enchufe el cable de alimentación a un cable de extensión.
- Revise que el cable de alimentación no tenga ningún daño antes de utilizarlo. No utilice cables de alimentación que estén dañados.
- Desconecte el cable de alimentación de la toma eléctrica sosteniendo firmemente el enchufe. No desconecte el cable de alimentación tirando solamente del cable.
- No se pare, circule, jale o coloque ningún objeto sobre el cable de alimentación.
- Para mayor seguridad, enchufe el carro a una conexión a tierra controlada por un interruptor de circuito GFI (interruptor de fallas de conexión a tierra).
- Los componentes eléctricos dañados pueden implicar riesgos de importancia para los usuarios, que no cubrirá la garantía. Un electricista calificado es quien deberá realizar siempre las reparaciones.
- Los dispositivos eléctricos no son juguetes. Los niños generalmente no están conscientes de los riesgos asociados con los dispositivos eléctricos. Este carro lo deberán utilizar siempre personas adultas o bajo su supervisión.